

## Architectural Shaped Ceiling Diffusers Aluminum • GeoFlow Modular Supply

Model:  GFB-10 • Supply • Narrow Tee Lay-in  
 GFBI-10 • Supply • Narrow Tee Lay-in • Insulated

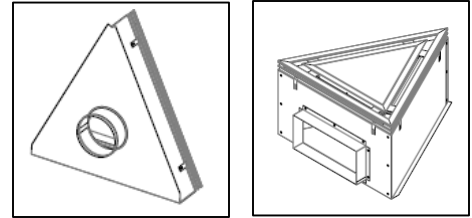

TRI

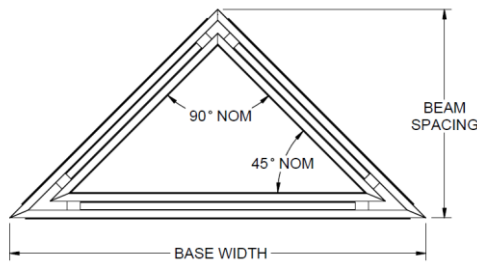

24" Beam x 48" Base

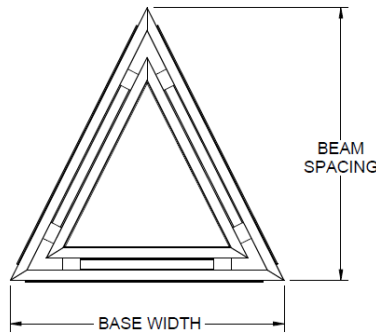

24" Beam x 24" Base  
48" Beam x 48" Base

TOP INLET

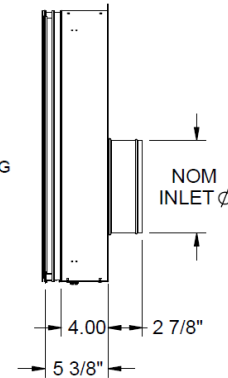

SIDE INLET

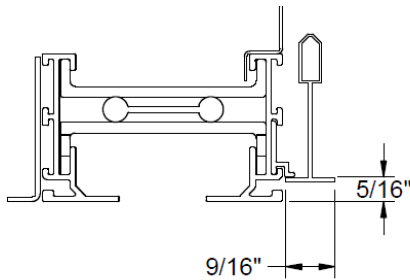
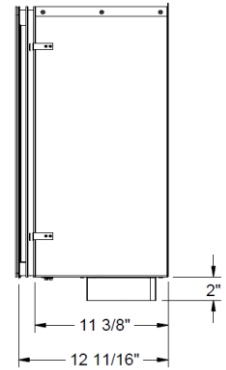

SHAPE	BEAM SPACING	BASE WIDTH	TOP INLET				SIDE INLET			
			6	8	10	12	4 X 7	4 X 13	6 X 13	6 X 19
TRI	24	24	✓	✓			✓	✓		
TRI	48	48			✓	✓			✓	✓
TRI	24	48		✓	✓			✓	✓	
TRI-R/L	24	48	✓	✓			✓	✓		

TRI-R

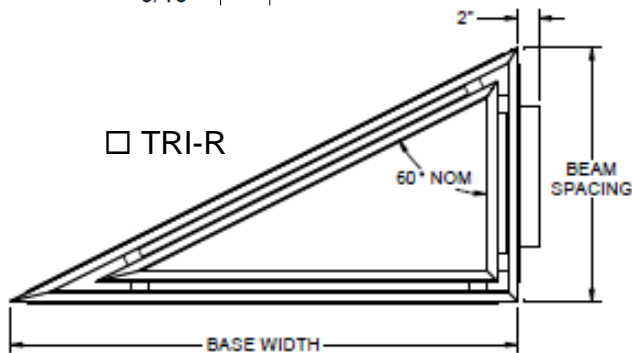

SIDE INLET

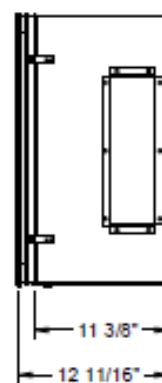

TOP INLET

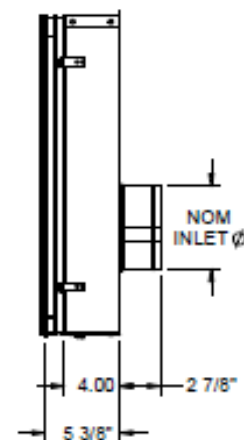

TRI-L

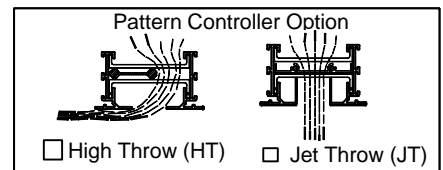
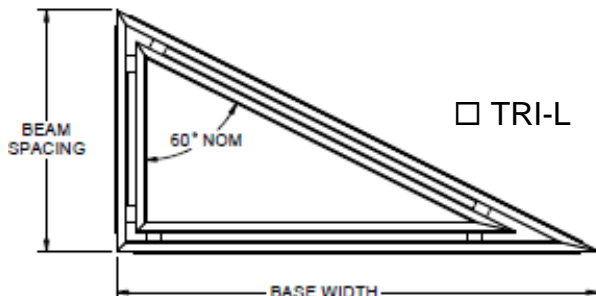

This submittal is meant to demonstrate general dimensions of this product. The drawings are not meant to detail every aspect of the product. Drawings are not to scale. Titus reserves the right to make changes without written notice.

## Architectural Shaped Ceiling Diffusers Aluminum • GeoFlow Modular Supply

Model:  GFB-10 • Supply • Narrow Tee Lay-in  
 GFBI-10 • Supply • Narrow Tee Lay-in • Insulated

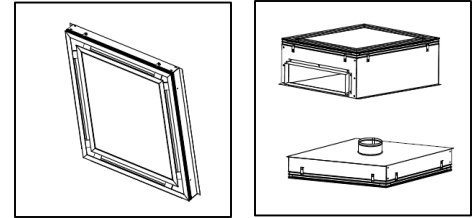

PRL-R

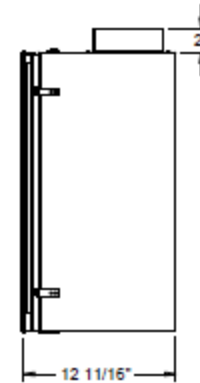
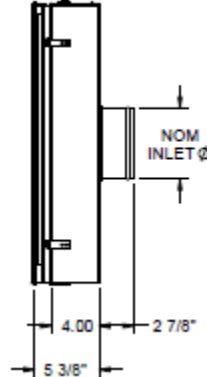
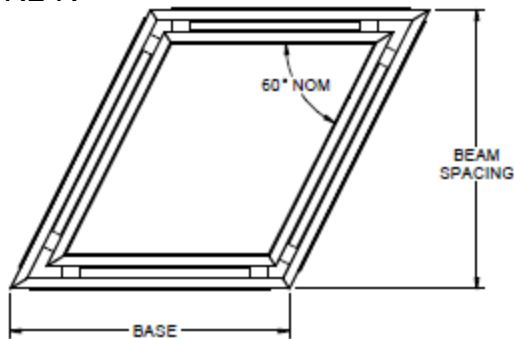

PRL-L

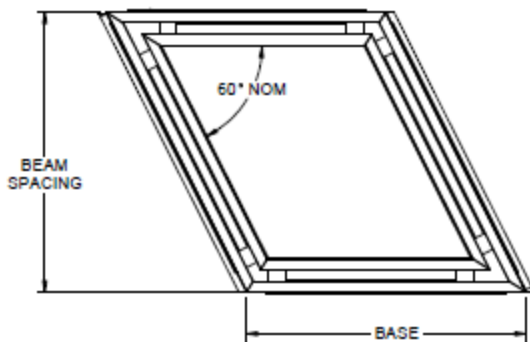

TOP INLET

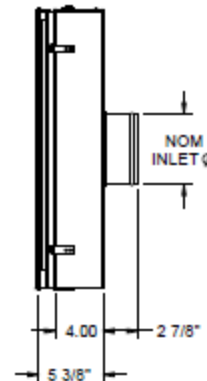

SIDE INLET

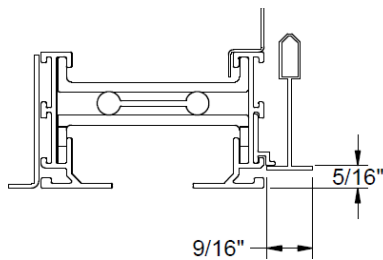
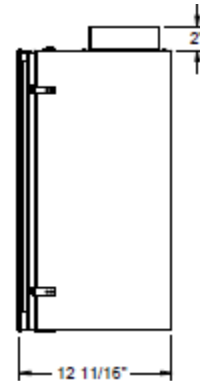

SHAPE	BEAM SPACING	BASE WIDTH	TOP INLET		SIDE INLET	
			6	8	4 X 7	4 X 13
PRL-R/L	24	24	✓	✓	✓	✓

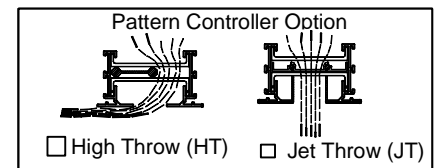

Standard Finish Options:  A26 Whitelume,  A01 Silverlume,  A05 Gun Metal Gray,  A84 Tech Black

### General Description

- Diffuser material is extruded aluminum. All diffuser components are black, face per Finish Option selected
- Plenum material is 24 gauge galvanized steel
- Choice of pattern controllers for high throw horizontal or jet throw vertical air distribution
- 2-7/8" beaded collar for fast, secure installation of flex duct
- Optional internal insulation

This submittal is meant to demonstrate general dimensions of this product. The drawings are not meant to detail every aspect of the product. Drawings are not to scale. Titus reserves the right to make changes without written notice.

## Architectural Shaped Ceiling Diffusers Aluminum • GeoFlow Modular Return

Model:  GFR-10 • Return • Narrow Tee Lay-in

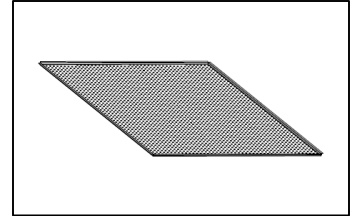

TRI

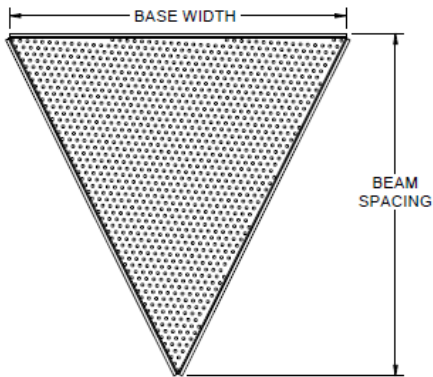

PRL-R (SHOWN)

PRL-L (OPPOSITE OF SHOWN)

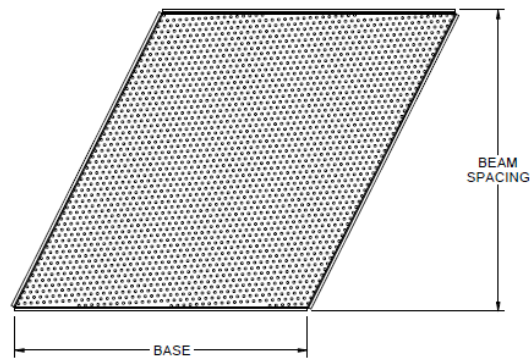

SHAPE	BEAM SPACING	BASE WIDTH
TRI	24	24
TRI	48	48
TRI	24	48
TRI-R	24	48
TRI-L	24	48

SHAPE	BEAM SPACING	BASE WIDTH
PRL-L	24	24
PRL-R	24	24

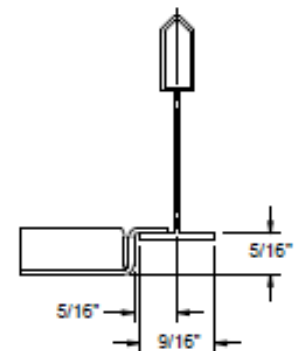

Tegular  
Border

Standard Finish Options:  A26 Whitelume,  A01 Silverlume,  A05 Gun Metal Gray,  A84 Tech Black

### General Description

- Return panel perforated material is 20 ga aluminum
- Border accommodates 9/16" tees for tegular appearance

This submittal is meant to demonstrate general dimensions of this product. The drawings are not meant to detail every aspect of the product. Drawings are not to scale. Titus reserves the right to make changes without written notice.